

APC Smart-UPS Uninterruptible Power Supply

Models

1400XLT, 2200XLT, 3000T, 5000T

User's Manual



Entire contents copyright ©1999 by American Power Conversion. All rights reserved. Reproduction in whole or in part without permission is prohibited. Smart-UPS is a registered trademark of APC. All other trademarks are the property of their respective owners.

This Safety Guide contains important instructions that should be followed during installation and maintenance of the APC equipment and batteries. It is intended for APC customers who setup, install, relocate, or maintain APC equipment.

Handling Safety

- Be careful. Do not lift heavy loads without assistance.

<18 kg (<40 lb.)



32-55 kg (70-120 lb.)

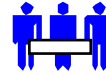

18-32 kg (40-70 lb.)

>55 kg (>120 lb.)





- Equipment with casters is built to move on a smooth surface without any obstacles.
- Do not use a ramp inclined at more than 10°.
- This equipment is intended for installation in a temperature-controlled indoor area (0 to 40°C (+32 to +104°F)), free of conductive contaminants.

Electrical Safety

- Do not work alone under hazardous conditions.
- High short circuit current through conductive materials could cause severe burns.
- A licensed electrician is required to install permanently wired equipment.
- Check that the power cord(s), plug(s), and sockets are in good condition.
- To reduce the risk of electric shock when grounding cannot be verified, disconnect the equipment from the AC power outlet before installing or connecting to other equipment. Reconnect the power cord only after all connections are made.
- Do not handle any kind of metallic connector before the power has been removed.
- Use one hand, whenever possible, to connect or disconnect signal cables to avoid a possible shock from touching two surfaces with different electrical grounds.
- Connect the equipment to a three wire AC outlet (two poles plus ground). The receptacle must be connected to appropriate branch circuit/mains protection (fuse or circuit breaker). Connection to any other type of receptacle may result in a shock hazard.



CAUTION! Deenergizing Safety

- If the equipment has an internal energy source (the battery), the output may be energized when the unit is not connected to an AC power outlet.
- To deenergize **pluggable equipment**: first press the Off button for more than one second to switch the equipment off. Next disconnect the equipment from the AC power outlet. Finally, disconnect the battery.
- To deenergize **permanently wired** equipment: set the power switch to standby . Next set the AC circuit breaker to standby . Then disconnect the batteries (including any expansion units). Finally, disconnect the AC power from the building power supply.
- Pluggable equipment includes a protective earth conductor which carries the leakage current from the load devices (computer equipment). Total leakage current must not exceed 3.5 mA.
- Use of this equipment in life support applications where failure of this equipment can reasonably be expected to cause the failure of the life support equipment or to significantly effect its safety or effectiveness is not recommended.



WARNING! Battery Safety

- **This equipment contains potentially hazardous voltages.** Do not attempt to disassemble the unit. The **only exception** is for equipment containing batteries. Battery replacement using the procedures below is permissible. Except for the battery, the unit contains no user serviceable parts. Repairs are performed only by factory trained service personnel.



Batteries must be recycled. Deliver the battery to an appropriate recycling facility or ship it to the supplier in the new battery's packing material. See the new battery instructions for more information.

- Do not dispose of batteries in a fire. The batteries may explode.
- Do not open or mutilate batteries. They contain an electrolyte which is toxic and harmful to the skin and eyes.
- To avoid personal injury due to energy hazard, remove wrist watches and jewelry such as rings when replacing the batteries. Use tools with insulated handles.
- Replace batteries with the same number and type of batteries as originally installed in the equipment.

Replacement and Recycling of Batteries

See your dealer or the Battery Replacement section of this *User's Manual* for information on replacement battery kits and battery recycling.

Table of Contents

Introduction.....	1
Unpacking.....	1
Installation	2
Initial Startup	7
Operating Instructions.....	9
Storage	11
Replacing the Battery.....	11
User Configuration Items.....	15
How to Determine On-Battery Run Time	15
Specifications.....	17
Troubleshooting.....	18
Service	19
APC Contact Information	19
Limited Warranty.....	19
Appendix A: XL Information.....	20
XL Installation	20
Smart-UPS Battery Protocol.....	21
Appendix B: Types of Racks and Mounting Hardware	23
Racks.....	23
Appendix C: Transporting Your Smart-UPS	24

Introduction

This Uninterruptible Power Supply (UPS) is designed to prevent blackouts, brownouts, sags and surges from reaching your computer and other valuable electronic equipment. This UPS also filters out small utility line fluctuations and isolates your equipment from large disturbances by internally disconnecting from the utility line, while supplying power from its internal batteries until the utility line returns to safe levels.

While running on battery, an internal alarm will sound (periodic beeps). The on/test button may be pressed to silence the UPS alarm.

If the utility power does not return, the UPS will continue supplying power to the connected equipment until exhausted. A continuous beeping will sound two minutes before the UPS's final low battery shutdown. If using a computer, you must manually save your files and power down before the UPS turns itself off, unless you are using PowerChute® interface software that provides automatic, unattended shutdown.

Unpacking

Inspection







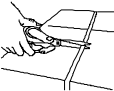

Inspect the UPS upon receipt. Notify the carrier and dealer if there is damage. The packaging is recyclable; save it for reuse or dispose of it properly.

Contents

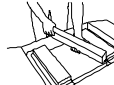
The shipping package contains the UPS, its batteries, and, for some rack mount units, rails to hold the UPS in a rack. The 5000 VA unit ships with the batteries separate from the UPS case.

How to Unpack the SU 5000 UPS

Move the UPS, in its shipping package, as close to the desired location as possible. Then follow these instructions:

-  Use scissors or a knife to cut the plastic straps and open the package.
-  Read this *User's Manual* for safety information and installation instructions.
-  Unpack the box containing the mounting rails.
-  Remove the foam spacers.
-  Lift off the cardboard box that covers the top and sides of the package. The bottom of the box is formed by a wooden pallet.
-  Pull the plastic bag down to expose the UPS.
-  Lift the UPS up and out of the box.
-  Remove the batteries from the pallet.

Caution:

The 5000 VA models (without batteries installed) require two people to lift due to their weight.

Installation

Installing your UPS requires five steps:

1. Position the UPS in the desired location. For rack mount units this may include installing the rails into the rack.
2. Connect the batteries. All UPSs ship with the batteries disconnected. In 5000 VA units you must also install the batteries in the UPS.
3. Connect equipment to the UPS.
4. Power up the UPS.
5. Install PowerChute® UPS monitoring software and accessories.

1. Position the UPS

Placement

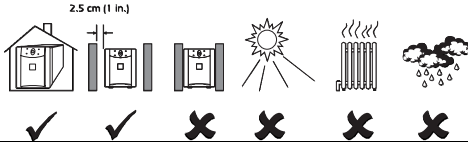

Install the UPS in a protected area that is free of excessive dust and has adequate air flow. Do not operate the UPS where the temperature and humidity are outside the specified limits.

Warning!

Changes or modifications to this unit not expressly approved by the party responsible for compliance could void the warranty.

Installing Rack Mount Units

The rack mount UPS comes with standard 19" (46.5 cm) rack mount brackets (ears) installed. The 3000 and 5000 VA models of the UPS are supplied with rails to support them in the rack. These supports may be used to ease installation for 19" or 23" racks. The supports are available as an accessory for the 1400 VA model. Contact your dealer or APC at the number listed under *APC Contact Information*, page 19, for more information. See *Appendix B: Types of Racks and Mounting Hardware*, page 23, for more information and installation instructions.

Caution:

Two or more people are required to install the 3000 and 5000 VA models due to their weight. The 5000 VA models must be put into position before the batteries are installed.

Installing the UPS in a rack involves a four-step process:

1. Determine the location of the UPS in the rack.
2. Install the mounting rails in the rack.
3. Load the UPS into the rack.
4. Attach the mounting brackets to the rack.

This section describes each step in detail.

Determine the Location of the UPS in the Rack

UPSs are heavy. Select a rack location sturdy enough to handle the weight. Mount the UPS at or near the bottom of the rack.

Select a rack location with adequate air flow that is free from excessive dust. Ensure that any air vents on the sides of the UPS are not blocked. Do not operate the UPS where temperature or humidity are outside the limits listed under *Specifications*, page 17.

Two additional sets of bracket holes, shown below at asterisks (*), are located on the sides of all rack mount UPS models except the 5000 VA. These holes allow mounting the brackets with a three inch or six inch setback. Move the mounting brackets back if desired to optimize the esthetic or physical requirements of the rack. The 5000 VA unit cannot be mounted in a setback position since it requires the full depth of the rack.

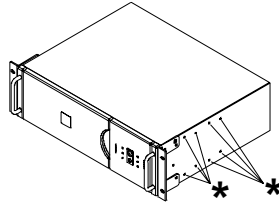

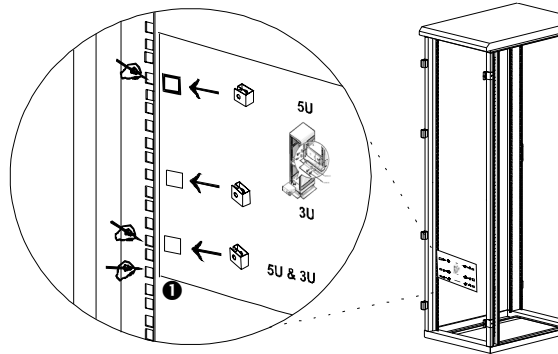

Caution:
Check the rack to make sure it won't tip after moving the mounting brackets.

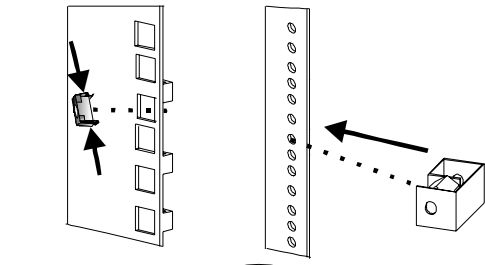

1. Determine where in the rack you'll mount the UPS. The SU5000 requires a space of 5U. Some racks have tick marks to indicate the U-spaces.
2. Using the mounting template provided (part number 990-0195), identify and mark the correct mounting holes for the UPS mounting brackets.
3. Locate and mark the bottom hole in the designated U-space ❶. The bottom screw on the mounting rail will attach to the bottom hole in the U-space.
4. Repeat steps 2 and 3 for the remaining three rack posts.



5. Prepare the rack holes, if necessary. Racks with threaded holes require no preparation.
- If your rack has round holes, insert clip nuts  (provided) into the holes marked in step 2.
- If your rack has square holes, insert either clip  or cage  nuts into the holes marked in step 2.

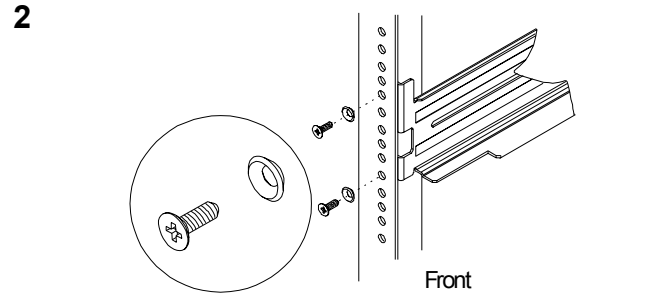
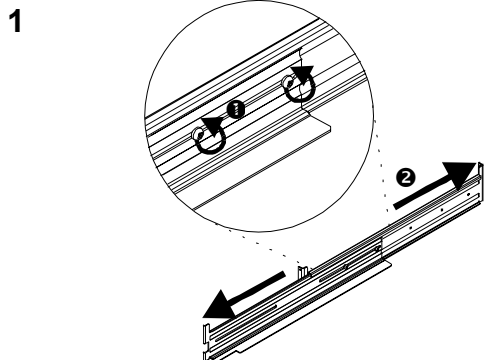

Remove the two screws ❶ that hold the rails together so that the rails can slide outward ❷. Do not detach the rails.

Align the bottom hole on the mounting rail with the bottom hole in the U-space (marked in step 3 above). Use the flat, Phillips head screws (10-32) and conical washers to attach the front rail to the rack. Position the rails so that the lip of the rail is on the bottom.

3

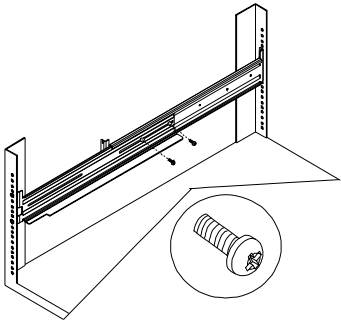

Expand the rails so that it spans from the front rack post to the back rack post. Replace the two screws (removed in step 1) that hold the rail sections together.

4

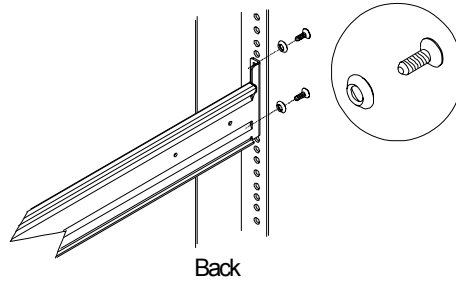

Attach the rail to the back rack post using the same hardware (10-32 flat head screws and conical washers) used in step 2. Repeat the process for the other rails.

Caution:

The 5000 VA models (without batteries installed) require two people to lift due to their weight.

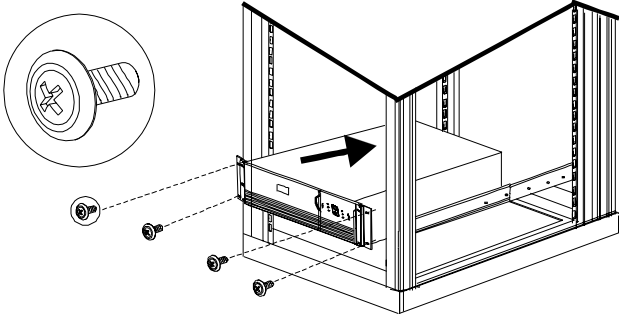

Load the UPS into the Rack

Supporting the UPS from the front and back, carefully align the unit with the rails. Slide the UPS into position.

Attach the Mounting Brackets to the Rack

Use the ornamental screws supplied with the UPS to attach the mounting brackets to the rack post.

Rack Mount Options

Accessory receptacle plates are available for the 3000 VA model. These plates offer different receptacle configurations and hard wire installation. Contact your dealer or the factory at the number listed in *APC Contact Information*, page 19.

2. Connect the Batteries

Note:

All UPSs ship with the batteries disconnected. In addition, 5000 VA units have the batteries shipped outside the UPS case so you must install the batteries before connecting them.

If you need to ship the UPS you must disconnect the batteries prior to shipment in order to comply with U.S. Federal Regulations. Refer to *Appendix C: Transporting Your Smart-UPS*, page 24, for details.

Graphics are not drawn to scale. They are shown for reference only.

Tower Units

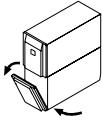

1. Grasp the top edge of the bottom front cover and **tilt** it out.

5000 VA

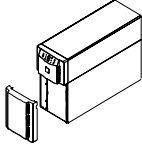

For 5000 VA units: Remove the front bezel by grasping the finger clips on the side of the bezel and carefully loosening the four (4) snaps. Skip to step 3.

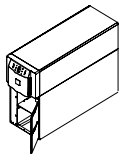

2. Unhook the bottom section of the front cover from the chassis and set it aside.
3. Use a screwdriver or a coin to remove the two (2) battery door screws and open the door.

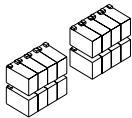

4. For 1400 – 3000 VA units: To connect the battery (or set), press the gray connector into the plug at the top of the battery housing.

Note:

The 5000 VA model has four (4) battery packs that must be installed. Be careful lifting the batteries - they are heavy. Support the bottom of the batteries as you move them.

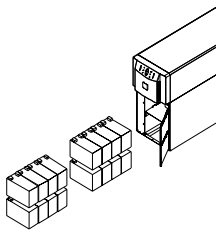

5. For 5000 VA units:
Hold the battery pack so that the leads are on top.
Slide the battery pack into the UPS.
Press the gray connector into the plug at the top of the battery compartment.
Tuck the white cord (that serves as a handle for the connector) neatly to the side.
6. For 5000 VA units, repeat step 5 for the remaining three (3) battery packs.
7. Close the battery door, replace the screws, and replace the lower front cover.

3U Rack Mount Units

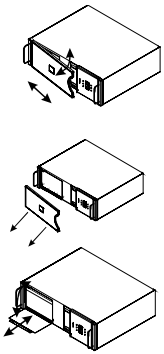

1. Reach into the finger pull and open the front cover. Swing the cover open as shown.
2. Unhook the side of the cover from the chassis and lift it away to expose the battery door.
3. Use a flat-blade or Phillips screwdriver or a coin to remove the two battery door screws and open the door.
4. Connect the battery leads to the battery. Connect the red wire to the positive (+) terminal and the black wire to the negative (-) terminal.
5. Close the battery door, replace the battery compartment screws, and replace the front cover.

5U Rack Mount Units

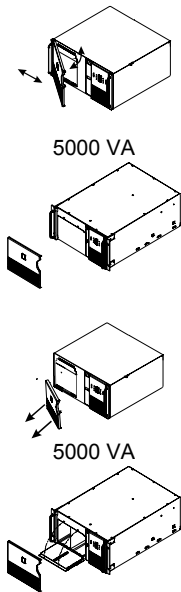

1. Reach into the finger pull and open the front cover. Swing the cover open as shown.

For 5000 VA units: Remove the front bezel by grasping the finger clips on the side of the bezel and carefully loosening the four (4) snaps. Skip to step 3.

2. Unhook the side of the cover from the chassis and lift it away to expose the battery door.
3. Use a screwdriver or a coin to remove the two (2) battery door screws and open the door.
4. To connect the battery (or set), press the gray connector into the plug at the top of the battery housing.

Note:

The 5000 VA model has four (4) battery packs that must be installed. Be careful lifting the batteries - they are heavy. Support the bottom of the batteries as you move them.

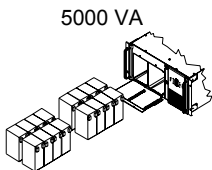

5. For 5000 VA units:
Hold the battery pack so that the leads are on the right hand side.
Slide the battery pack into the UPS.
Press the gray connector into the plug at the right-hand side of the battery compartment.
Tuck the white cord (that serves as a handle for the connector) neatly to the side.
6. For 5000 VA units, repeat step 5 for the remaining three (3) battery packs.
7. Close the battery door, replace the screws, and replace the front cover.

3. Connect Power and Equipment to the UPS

- Connect the UPS line cord (L6-30 plug) into the electrical outlet.
- Use your equipment's power cords to connect to the UPS.

Caution:

DO NOT use a standard serial interface cable to connect to the Computer Interface Port on the UPS. Standard serial interface cables are incompatible with the UPS connector. Use the cable provided with your UPS.

- Turn on all connected equipment.

4. Connect Power to the UPS and Accessories

- Press the UPS's ON switch to turn on your UPS. This will power-up connected equipment.
- The unit performs a self-test automatically when turned on, and every two weeks thereafter.
- The UPS charges its battery whenever it is connected to utility power. The battery charges fully during the first four hours of normal operation. Do not expect full runtime during this initial charge period.

5. Install PowerChute and Accessories

Note:

This UPS is equipped with a SmartSlot for accessories. See the APC Website (www.apcc.com) for available accessories. If a standard accessory is installed in this UPS, a User's Manual for the accessory is included in the package.

For additional computer system security, install PowerChute UPS monitoring software. It provides automatic unattended shutdown capabilities on most major network operating systems. Once PowerChute is loaded, install the PowerChute® black communication cable between UPS and computer. See the *Software Installation: Instruction Sheet* for details.

Initial Startup

Rear Views

1400 VA - 3000 VA Tower Models

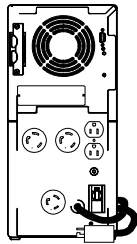

1400 VA Rack Mount Model (5U)

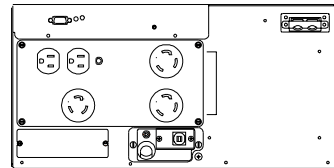

2200 VA & 3000 VA Rack Mount Model (3U)

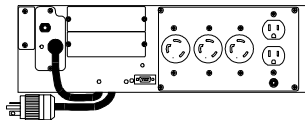

Rack Mount Model (X136 Option)

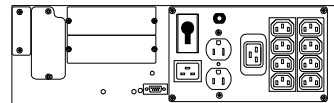

5000 VA Tower Model

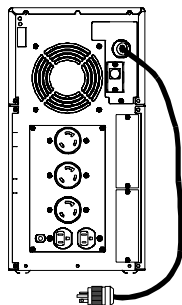

5000 VA Rack Mount Model

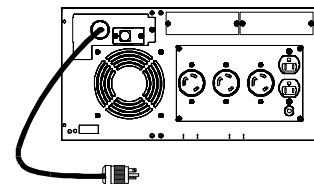

Charge the battery

The UPS charges its battery whenever it is connected to utility power. The battery will charge fully during the first four hours of normal operation. Do not expect full runtime during this initial charge period.

Connect Computer Interface Port (Optional)

Power management software and interface kits can be used with this UPS. Use only kits supplied or approved by the manufacturer. If used, connect the interface cable to the 9-pin computer interface port on the back panel of the UPS. Secure the connector's screws to complete the connection.

Caution:

DO NOT use a standard serial interface cable to connect to the Computer Interface Port on the UPS. Standard serial interface cables are incompatible with the UPS connector. Use the cable provided with your UPS.

Connect Ground Leads to TVSS Connector (Optional)

The UPS features a TVSS connector for connecting the ground lead on transient voltage surge-suppression (TVSS) devices such as telephone and network line protectors. The TVSS connector provides grounding through the UPS's power cord ground conductor. To make a connection to the TVSS connector, loosen the screw and connect the surge suppression device's ground lead. Tighten the screw to secure the lead.

Battery Pack Connector (Optional)

Use the battery pack connector (on units that have one) to connect the optional external battery pack. See *Appendix A: XL Information*, page 20, for instructions.

Voltage Sensitivity

The UPS detects line voltage distortions such as spikes, notches, dips, and swells, as well as distortions caused by operation with inexpensive fuel-powered generators. By default, the UPS reacts to distortions by transferring to on-battery operation to protect the loads. Where power quality is poor, the UPS may frequently transfer to on-battery operation. If the loads can operate normally under such conditions, battery capacity and service life may be conserved by reducing the sensitivity of the UPS.

 To reduce UPS sensitivity, press the configuration button on the rear panel. Use a pointed object such as a pen to press the button. Press it once to set the UPS's sensitivity to **reduced**. Press it again to set the sensitivity to **low**. Press the button a third time to reset **normal** sensitivity.

 **normal** When the UPS is set to normal sensitivity, the configuration LED is brightly lit.

 **reduced** When it is set to reduced sensitivity, the LED is dimly lit.

 **low** When it is set to low sensitivity, the LED is off.

Low Battery Warning Interval

By default, the low battery warning occurs when there are approximately two minutes of on-battery run time remaining. This may not be enough time to gracefully shut down some protected computer systems.

 To change the warning interval, press the rear panel configuration button while pressing and holding the front-panel on/test button.

 **2 min.** When the LED is brightly lit, the low battery warning interval is roughly 2 minutes. This is the initial setting.

 **5 min.** When the LED is dimly lit, the low battery warning interval to approximately five minutes.

 **7 min.** When the LED is off, the low battery warning interval is approximately seven minutes.
Press the button a third time to reset the interval to two minutes.

Operating Instructions

Switch On — Switch Off

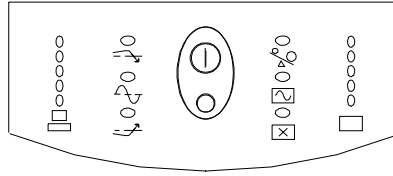

- ① With the UPS plugged in, press and release the large upper on/test button to supply power to the loads. The loads are immediately powered while the UPS beeps and performs a self-test.
- Press and release the small, lower off button to turn off power to the loads. It may be convenient to use the UPS as a master on/off switch for the protected equipment.

Note:

Whenever the UPS is plugged in and utility voltage is present, the charger maintains battery charge.

 The on-line LED illuminates when the UPS is supplying utility power to the loads.

On Battery

During on-battery operation, the on-battery LED illuminates and the UPS sounds an audible alarm consisting of four beeps every 30 seconds. The alarm stops when the UPS returns to on-line operation.

Battery Charge Bar Graph

 The 5-LED display on the right of the front panel shows the present charge of the UPS's battery as a percentage of the battery's capacity. When all five LEDs light, the battery is fully charged. The top LED goes out whenever the battery is not 100% charged. When the lowest LED is flashing, the battery can supply less than two minutes of run time for the load. The battery capacity threshold is shown in the figure to the left (values are not listed on the UPS).

Shutdown Mode

In shutdown mode the UPS stops supplying power to the load, waiting for the return of utility power. If there is no utility power present, external devices (e.g., servers) connected to the computer interface or the accessory slot can command the UPS to shut down. This is normally done to preserve battery capacity after the graceful shutdown of protected servers. The UPS will scroll the front panel indicators sequentially in shutdown mode.

Self-test

The UPS performs a self-test automatically when turned on, and every two weeks thereafter (by default). Automatic self-test eases maintenance requirements by eliminating the need for periodic manual self-tests.

During the self-test, the UPS briefly operates the loads on-battery. If the UPS passes the self-test, it returns to on-line operation.

 If the UPS fails the self-test it immediately returns to on-line operation and lights the replace battery LED.

The loads are not affected by a failed test. Recharge the battery overnight and perform the self-test again. If the replace battery LED is still on, replace the battery using the procedure in *Replacing the Battery*, page 11.

Replace Battery

If the battery fails a self-test, the UPS emits short beeps for one minute and the replace battery LED illuminates. The UPS repeats the alarm every five hours. Perform the self-test procedure to confirm replace battery conditions. The alarm stops when the battery passes the self-test.

Load Bar Graph

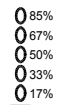
 The 5-LED display on the left of the front panel represents the power drawn from the UPS as a percentage of total capacity. For example, if three LEDs are lit, the load is drawing between 50% and 67% of the UPS's capacity. If all five LEDs light, thoroughly test your complete system to make sure that the UPS will not become overloaded.

 In the graph to the left the load capacity threshold is listed next to the LED (values are not listed on the UPS).

Overload

When the UPS is overloaded (the connected loads exceed the maximum specified in the “maximum load” section under *Specifications*, page 17), the overload LED comes on and the UPS emits a sustained tone. The alarm remains on until the overload is removed. Disconnect nonessential load equipment from the UPS to eliminate the overload.

SmartTrim

The SmartTrim LED comes on to indicate that the UPS is compensating for a high voltage.

SmartBoost

The SmartBoost LED comes on to indicate that the UPS is compensating for a low voltage.

Low Battery

When the UPS is operating on-battery and the energy reserve of the battery runs low, the UPS beeps continuously until the UPS shuts down from battery exhaustion or returns to on-line operation.

Cold Start

When the UPS is off and there is no utility power, use the cold start feature to apply power to the loads from the UPS's battery.

Note:

Cold start is not a normal condition.

① Press and hold the on/test button until the UPS beeps.

Release the on/test button during the beep and the loads are powered within four seconds.

Utility Voltage Bar Graph

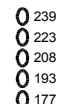
 This UPS has a diagnostic feature that displays the utility voltage. With the UPS plugged into the normal utility power, press and hold the on/test button to see the utility voltage bar graph display. After approximately four seconds the 5-LED display on the right of the front panel shows the utility input voltage. Refer to the figure to the left for the voltage reading (values are not listed on the UPS).



The display indicates that the voltage is between the displayed value from the list and the next higher value. For example, with three LEDs lit, the input voltage is between 208 and 223 VAC.

If no LEDs come on and the UPS is plugged into a working AC power outlet, the line voltage is extremely low.

If all five LEDs come on, the line voltage is extremely high and should be checked by an electrician.

Note:

The UPS starts a self-test as a part of this procedure. The self-test does not affect the voltage display. The utility voltage bar graph has a margin of error of $\pm 4\%$.

Storage

Storage Conditions

Store the UPS covered and upright in a cool, dry location, with its battery fully charged. Before storing, charge the UPS for at least two hours. Remove any accessories in the accessory slot and disconnect any cables connected to the computer interface port to avoid unnecessarily draining the battery.

Extended storage

At -15 to +30 °C (+5 to +86 °F), charge the UPS's battery every six months.

At +30 to +45 °C (+86 to +113 °F), charge the UPS's battery every three months.

Replacing the Battery

This UPS has an easy to replace hot-swappable battery. Battery replacement is a safe procedure, isolated from electrical hazards. You may leave the UPS and loads on for the following procedure. See your dealer or call the number listed under *APC Contact Information*, page 19, for information on replacement battery cartridges.

Note:

**Please read the cautions in the Safety section at the beginning of this *User's Manual*.
Once the battery is disconnected, the loads are not protected from power outages.**

Model Number	Replacement Battery Cartridge (RBC) #
SU1400XLTNET	RBC 11
SU2200XLTNET	RBC 11
SU3000TNET	RBC 11
SU5000T	RBC 12
SU1400RMXLTNET	RBC 11
SU2200RMXLTNET	RBC 11
SU3000RMT3U	RBC 12
SU5000RMT5U	RBC 12

Battery Replacement Procedure - Tower Units

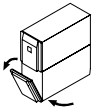

5000 VA

1. Grasp the top edge of the bottom front cover and **tilt** it out.

For the 5000 VA unit: Remove the front bezel by grasping the finger clips on the side of the bezel and carefully loosening the four (4) snaps. Skip to step 3.

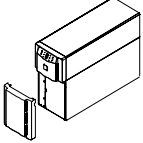

1400-3000 VA

2. Unhook the bottom section of the front cover from the chassis and set it aside.
3. Use a screwdriver or a coin to remove the two (2) battery door screws and open the door.
4. Disconnect the front battery pack:

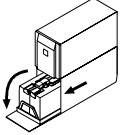

5000 VA

For the 1400 – 3000 VA models, gently but firmly pull the red and black wires at the top of the battery housing to disconnect the gray connector plug from the UPS.

For the 5000 VA model, grip the white cord on the front set of batteries and pull firmly to disconnect the connector.

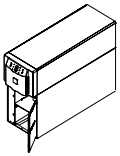

5. Pull the front battery out of the UPS by pulling on the clear label, *not* the white cord. Remove the foam spacer and set it aside. (The 5000 VA unit does not use foam spacers.)

Notes:

Be careful removing the batteries - they are heavy. Support the bottom of the batteries as you remove them.

The 5000 VA model has four of batteries, two in each compartment. Exercise special care when removing the top set.

1400-3000 VA

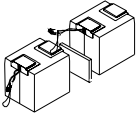

6. Disconnect and remove the second battery pack by repeating steps 4 and 5.
7. Replace the back battery (or set).
For 5000 VA units:
Hold the battery pack so that the leads are on top.
Slide the battery pack into the UPS.

5000 VA

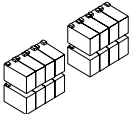

8. Reconnect the battery (or set.)
For 1400 – 3000 VA units: Press the gray connector into the plug at the top of the battery housing. Replace the foam spacer (if used). Replace the front battery (or set) into the UPS and reconnect.

For 5000 VA units:

Press the gray connector into the plug at the top of the battery compartment.

Tuck the white cord (that serves as a handle for the connector) neatly to the side.

Notes:

For the 5000 VA model, repeat steps 4 through 8 for the second set of battery packs.

Small sparks at the battery connectors are normal during connection.

9. Close the battery door, replace the screws, and replace the lower front cover or bezel.

Batteries must be recycled. Deliver the battery to an appropriate recycling facility or ship it to the supplier in the new battery's packing material. See the new battery instructions for more information.



Battery Replacement Procedure - 3U Rack Mount Units

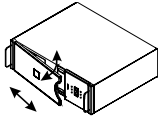

1. Reach into the finger pull and open the front cover. Swing the cover open as shown.

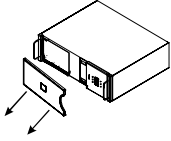

2. Unhook the side of the cover from the chassis and lift it away to expose the battery door.

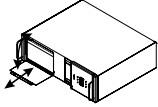

3. Use a flat-blade or Phillips screwdriver or a coin to remove the two battery door screws and open the door.

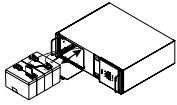

4. Grasp the tab and gently pull the battery out of the UPS.

5. Disconnect the battery leads. Loosen the connectors by gently wiggling them while pulling straight back from the battery connector.

6. Connect the battery leads to the new battery. Connect the red wire to the positive (+) terminal and the black wire to the negative (-) terminal.

7. Slide the battery into the UPS.

8. Close the battery door, replace the battery compartment screws, and replace the front cover.

Notes:

Be careful removing the batteries - they are heavy.

Small sparks at the battery connectors are normal during connection.



Batteries must be recycled. Deliver the battery to an appropriate recycling facility or ship it to the supplier in the new battery's packing material. See the new battery instructions for more information.

Battery Replacement Procedure - 5U Rack Mount Units

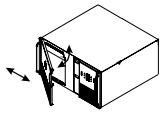

5000 VA

1. Reach into the finger pull and open the front cover. Swing the cover open as shown.

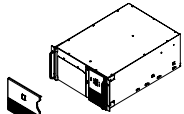

For 5000 VA units: Remove the front bezel by grasping the finger clips on the side of the bezel and carefully loosening the four (4) snaps. Skip to step 3.

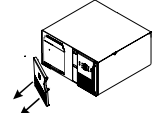

5000 VA

2. Unhook the side of the cover from the chassis and lift it away to expose the battery door.

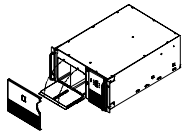

1400 VA

3. Use a screwdriver or a coin to remove the two (2) battery door screws and open the door.

4. Disconnect the front battery pack:

For the 1400 – 3000 VA models, gently but firmly pull the red and black wires at the top of the battery housing to disconnect the gray connector plug from the UPS.

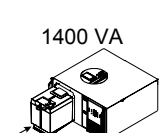

5000 VA

For the 5000 VA model, grip the white cord on the front set of batteries and pull firmly to disconnect the connector.

5. Pull the front battery out of the UPS by pulling on the clear label, *not* the white cord. Remove the foam spacer and set it aside. (The 5000 VA unit does not use foam spacers.)

Notes:

Be careful removing the batteries - they are heavy. Support the bottom of the batteries as you remove them.

The 5000 VA model has four sets of batteries.

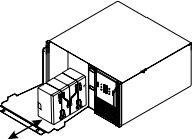

1400 VA

6. Reach into the battery compartment and grasp the white cord on the other battery connector. Pull firmly to disconnect the connector and remove the rear set of batteries.

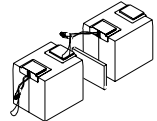

7. Slide the rear set of new batteries into the unit.

For 1400 – 3000 VA units: Hold the connector down below the top of the batteries and toward the door, otherwise the assembly will not fit.

Guide the connector over the top of the batteries and press firmly to connect it to the rear connector of the battery compartment.

5000 VA

For 5000 VA units: Hold the battery pack so that the leads are on the right-hand side. Slide the battery pack into the UPS.

Press the gray connector into the plug at the top of the battery compartment.

Tuck the white cord (that serves as a handle for the connector) neatly to the side.

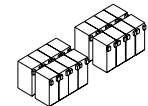

8. Set the foam spacer (if used) against the rear batteries to prevent the wires from being pinched.

9. Slide the front set of batteries in, then guide the connector over the batteries and press firmly to connect it to the front connector of the battery compartment.

Notes:

For the 5000 VA model, repeat steps 4 through 9 for the second set of batteries.

Small sparks at the battery connectors are normal during connection.

10. Close the battery door, replace the screws, and replace the front cover.

Batteries must be recycled. Deliver the battery to an appropriate recycling facility or ship it to the supplier in the new battery's packing material. See the new battery instructions for more information.



User Configuration Items

Note: Setting these items requires optional software or hardware.			
Function	Factory Default	User Selectable Choices	Description
Automatic Self-Test	Every 14 days (336 hours)	Every 7 days (168 hours), On Startup Only, No Self-Test	Sets the interval at which the UPS will execute a self-test.
UPS ID	UPS_IDEN	Up to eight characters to define the UPS.	Use this field to uniquely identify the UPS for network management purposes.
Date of Last Battery Replacement	Manufacture Date	Date of Battery Replacement	Reset this date on battery replacement.
Minimum Capacity Before Return from Shutdown	0 percent	15, 50, 90 percent	The UPS will charge its batteries to the specified percentage before return from a shutdown.
Sensitivity	Normal	Reduced, Low	Set lower than normal sensitivity to avoid lowered battery capacity and service life in situations where the load can tolerate minor power disturbances.
Duration of Low Battery Warning	2 minutes	5, 7, 10 minutes	Sets the time before shutdown at which the UPS issues a low battery warning. Set higher than the default only if the OS needs the time for graceful shutdown.
Alarm Delay After Line Fail	5 second delay	30 second delay, At Low Battery Condition, No Alarm	To avoid alarms for minor power glitches, set the alarm delay.
Shutdown Delay	20 seconds	180, 300, 600 seconds	Sets the interval between when the UPS receives a shutdown command and when shutdown occurs.
Synchronized Turn-on Delay	0 seconds	60, 180, 300 seconds	To avoid branch circuit overload, the UPS will wait the specified time after the return of utility power before turn-on.
High Transfer Point	229	224, 234, 239	To avoid unnecessary battery usage, set the High Transfer Point higher if the utility voltage is chronically high and the load is known to work well under this condition.
Low Transfer Point	177	168, 172, 182	Set the Low Transfer Point lower if the utility voltage is chronically low and the load can tolerate this condition.

How to Determine On-Battery Run Time

Note:

**UPS battery life differs based on usage and environment.
APC recommends that the battery/batteries be changed once every two years.**

Tower and 5U Models - 1400VA and 2200VA Models

Typical On-Battery Runtime Versus Load, in Hours											
Load (VA)	Internal Battery	1 Battery Pack	2 Battery Packs	3 Battery Packs	4 Battery Packs	5 Battery Packs	6 Battery Packs	7 Battery Packs	8 Battery Packs	9 Battery Packs	10 Battery Packs
100	4.50	9.75	15.42	21.08	26.75	32.42	38.08	43.75	49.41	55.08	60.75
200	2.75	6.25	9.75	13.50	17.25	21.08	24.83	28.58	32.33	36.17	39.92
300	1.83	4.50	7.08	9.67	12.50	15.33	18.08	20.92	23.75	26.58	29.42
400	1.33	3.42	5.42	7.50	9.58	11.83	14.08	16.33	18.58	20.75	23.00
500	1.05	2.67	4.42	6.08	7.83	9.50	11.33	13.25	15.08	16.92	18.75
600	0.85	2.17	3.67	5.08	6.50	8.00	9.42	11.00	12.58	14.17	15.75
700	0.68	1.75	3.00	4.25	5.50	6.75	8.00	9.26	10.67	12.00	13.33
800	0.58	1.50	2.58	3.75	4.83	5.92	7.08	8.17	9.25	10.50	11.67
900	0.48	1.27	2.25	3.25	4.25	5.25	6.25	7.25	8.25	9.17	10.25
1000	0.43	1.12	2.00	2.83	3.75	4.67	5.58	6.42	7.33	8.25	9.17
1200	0.33	0.88	1.52	2.25	3.00	3.75	4.50	5.25	6.00	6.75	7.50
1400	0.27	0.70	1.22	1.83	2.50	3.08	3.75	4.42	5.00	5.67	6.25
1600	0.22	0.57	1.00	1.47	2.00	2.58	3.08	3.67	4.17	4.75	5.25
1800	0.18	0.48	0.87	1.25	1.75	2.17	2.67	3.17	3.67	4.17	4.67
2000	0.15	0.42	0.73	1.08	1.45	1.92	2.33	2.75	3.17	3.67	4.08
2200	0.13	0.35	0.63	0.93	1.25	1.67	2.00	2.42	2.83	3.17	3.58

Tower and 5U Rack Mount Models - 3000 & 5000 VA Models

Typical On-Battery Run Time Versus Load, in Hours			
Load	3000 VA Internal Battery	3000 VA w/ 1 Battery Pack	5000 VA Internal Battery
100 VA	3.80	8.18	7.17
150 VA	3.05	6.57	5.95
200 VA	2.35	5.42	5.04
300 VA	1.83	4.08	3.88
400 VA	1.40	3.22	2.96
500 VA	1.12	2.62	2.37
600 VA	0.90	2.18	1.92
800 VA	0.58	1.6	1.40
1000 VA	0.43	1.22	1.06
1200 VA	0.33	0.97	0.83
1400 VA	0.27	0.70	0.65
1600 VA	0.22	0.58	0.54
2000 VA	0.17	0.42	0.39
2200 VA	0.13	0.37	0.33
2500 VA	0.11	0.30	0.26
3000 VA	0.08	0.22	0.19
3500 VA	-	-	0.16
4000 VA	-	-	0.13
4500 VA	-	-	0.11
5000 VA	-	-	0.09

3U Rack Mount Models - 2200 & 3000 VA Models

Typical On-Battery Run Time Versus Load, in Hours		
Load	NS2200RM SU2200RM (3U)	NS3000RM SU3000RM (3U)
50 VA	5.60	4.53
75 VA	4.73	3.93
100 VA	4.08	3.45
150 VA	3.15	2.75
200 VA	2.53	2.25
250 VA	2.10	1.88
300 VA	1.77	1.60
350 VA	1.52	1.40
400 VA	1.32	1.23
450 VA	1.16	1.08
500 VA	1.03	0.97
550 VA	0.92	0.87
600 VA	0.83	0.78
700 VA	0.67	0.63
800 VA	0.54	0.55
900 VA	0.50	0.48
1000 VA	0.45	0.43
1200 VA	0.35	0.33
1400 VA	0.28	0.27
1600 VA	0.23	0.22
2000 VA	0.15	0.15
2200 VA	0.13	0.13
2500 VA	-	0.10
3000 VA	-	0.06

Specifications

	1400 VA	2200 VA	3000 VA	5000 VA
Acceptable input voltage	0 - 325 VAC			
Input voltage (on-line operation)*	160 - 253 VAC			
208 volt output range*	177 - 229 VAC			
120 volt output range * with 400 VA load with no load	95 - 130 VAC 100 - 135 VAC			
Nominal input frequency	50 or 60 Hz, autosensing			
Input protection	Resettable circuit breaker			
Frequency limits (on-line operation)	47 to 63 Hz			
Transfer time	2 ms typical, 4.5 ms maximum			
Maximum load, total	1400 VA/950 W	2200 VA/1600 W	3000 VA/2250 W	5000 VA/3750 W
Maximum load, 120V auxiliary	400 VA/400 W			
On-battery output voltage	208 VAC			
On-battery frequency	50 or 60 Hz, 0.1 Hz; unless synchronized to utility during brownout			
On-battery waveshape	Low-distortion sine wave			
Overload protection (on-battery)	Overcurrent and short-circuit protected, latching shutdown on overload			
Overload protection (on-line)	2 pole, 20 Amp UL certified input circuit breaker			
Overload protection (120 VAC auxiliary)	Transformer and output protected by resettable thermal circuit breaker (on-line and on-battery)			
Surge energy rating (one time, 10/1000 μ s waveform)	1120 J			
Surge current capability (one time, 8/20 μ s waveform)	6500 A maximum			
Surge response time	0 ns (instantaneous) normal mode; <5 ns common mode			
Surge voltage let-through (percentage of applied ANSI C62.41 Cat. A 6 kV test waveform)	0.30%			
Noise filter	Normal and common mode EMI/RFI suppression, 100 kHz to 10 MHz			
Battery type	Spill proof, maintenance free, sealed lead-acid			
Typical battery life	3 to 6 years, depending on number of discharge cycles and ambient temperature			
Typical recharge time	2 to 5 hours from total discharge			
Operating temperature	0 to 40°C (+32 to +104°F)			
Storage temperature	-15 to +45°C (+5 to +113°F)			
Operating and storage relative humidity	5 to 95%, non-condensing			
Operating elevation	0 to +3,000 m (0 to +10,000 ft.)			
Storage elevation	0 to +15,000 m (0 to +50,000 ft.)			
Electromagnetic immunity	IEC 801-2 level IV, 801-3 level III, 801-4 level IV			
Audible noise in dBA at 1 m (3 ft.)	<55			
Safety approvals	Listed to UL 1778, certified to CSA 107.1			
EMI verification	FCC/DOC Class A verified			
	5U Units			RM Units
Size (W x H x D)	43.2 x 19.6 x 54.6 cm (17.0 x 8.7 x 21.5 in.)			43.2 x 19.6 x 62.2 cm (17.0 x 8.7 x 24.5 in.)
Weight - net (shipping)	120 (143) lb. 54.3 (64.8) kg	137 (160) lb. 62.0 (72.5) kg	137 (160) lb. 62.0 (72.5) kg	225 (245) lb. 102 (111) kg
	3U Units			Tower Units
Size (W x H x D)	43.2 x 13.3 x 62.2 cm (17.0 x 5.25 x 24.5 in.)			19.6 x 43.2 x 62.2 cm (8.7 x 17.5 x 26.0 in.)
Weight - net (shipping)	128 (148) lb. 58 (67) kg			230 (250) lb. 105 (114) kg

Troubleshooting

Use the chart below to solve minor UPS installation problems. Contact APC Technical Support Staff for assistance with complex UPS problems. See *APC Contact Information*, page 19, for a location near you.

Problem and Possible Cause	Solution
<p>UPS will not turn on.</p> <ul style="list-style-type: none"> • ON button not pushed. • UPS not connected to AC power supply. • UPS input circuit breaker tripped. • Very low or no utility voltage. • Battery not connected properly. 	<p>Press the ON button once to power the UPS and the load.</p> <p>Check that the power cable from the UPS to the power supply is securely connected at both ends.</p> <p>Reduce the load on the UPS by unplugging equipment and reset the circuit breaker (on back of UPS) by pressing the plunger back in.</p> <p>Check the AC power supply to the UPS with a table lamp. If very dim, have the utility voltage checked.</p> <p>Confirm the battery connections.</p>
<p>UPS will not turn off.</p> <ul style="list-style-type: none"> • Internal UPS fault. 	<p>Do not attempt to use the UPS. Unplug the UPS and have it serviced immediately.</p>
<p>UPS operates on-battery although normal line voltage exists.</p> <ul style="list-style-type: none"> • UPS's input circuit breaker tripped. • Very high, low, or distorted line voltage. Inexpensive fuel powered generators can distort the voltage. 	<p>Reduce the load on the UPS by unplugging equipment and reset the circuit breaker (on back of UPS) by pressing the plunger back in.</p> <p>Move the UPS to a different outlet on a different circuit.</p> <p>Test the input voltage with the utility voltage display. If acceptable to the load, reduce the UPS's sensitivity. Refer to <i>Voltage Sensitivity</i>, page 8, for instructions.</p>
<p>UPS beeps occasionally.</p> <ul style="list-style-type: none"> • Normal UPS operation. 	<p>None. The UPS is protecting the load.</p>
<p>UPS does not provide expected backup time.</p> <ul style="list-style-type: none"> • The UPS's battery is weak due to recent outage or is near the end of its service life. • The UPS is overloaded. 	<p>Charge the battery. Batteries require recharging after extended outages. Also, they wear faster when put into service often or when operated at elevated temperatures. If the battery is near the end of its service life, consider replacing the battery even if the replace battery indicator is not yet lit.</p> <p>Check the UPS's load display. Unplug less needed equipment, such as printers.</p>
<p>Front panel indicators flash sequentially.</p> <ul style="list-style-type: none"> • The UPS has been shut down by remote control. 	<p>None. The UPS will restart automatically when utility power returns.</p>
<p>All indicators are lit and UPS emits a constant beeping.</p> <ul style="list-style-type: none"> • Internal UPS fault. 	<p>Do not attempt to use the UPS. Turn the UPS off and have it serviced immediately.</p>
<p>All indicators are off and UPS is plugged into wall outlet.</p> <ul style="list-style-type: none"> • The UPS is shut down and the battery is discharged from an extended outage. 	<p>None. The UPS will return to normal operation when the power is restored and the battery has a sufficient charge.</p>
<p>The replace battery light is lit.</p> <ul style="list-style-type: none"> • Weak batteries. • Replacement batteries not connected properly. 	<p>Do another self test to see if it clears.</p> <p>Confirm the battery connections.</p>

Service

If the UPS requires service do not return it to the dealer!

Follow these steps:

1. Review the problems discussed in *Troubleshooting*, page 18, to eliminate common problems.
2. Verify that no circuit breakers are tripped. A tripped circuit breaker is the most common UPS problem!
3. If the problem persists, call customer service or visit the APC Internet Website (www.apcc.com).
 - Note the model number of the UPS, the serial number, and the date purchased. A technician will ask you to describe the problem and try to solve it over the phone, if possible. If this is not possible the technician will issue a Return Merchandise Authorization Number (RMA#).
 - If the UPS is under warranty, repairs are free. If not, there is a repair charge.
4. Pack the UPS in its original packaging. If the original packing is not available, ask customer service about obtaining a new set.

Note:

Pack the UPS properly to avoid damage in transit. Never use Styrofoam beads for packaging. Damage sustained in transit is not covered under warranty.

5. Mark the RMA# on the outside of the package.
6. Return the UPS by insured, prepaid carrier to the address given to you by Customer Service.

APC Contact Information



Internet: <http://www.apcc.com>

North America

Phone1.800.800.4272
Fax1.401.788.2743
Email.....apctech@apcc.com

Latin America

Argentina0800.9.APCC (0800.9.2722)
Brazil0800.12.72.21
Colombia.....980.15.39.47
Mexico95.800.804.4283
Uruguay000.413.598.2139
Venezuela.....8001.2856
Email.....apctchla@apcc.com

Limited Warranty

American Power Conversion (APC) warrants its products to be free from defects in materials and workmanship for a period of two years from the date of purchase. Its obligation under this warranty is limited to repairing or replacing, at its own sole option, any such defective products. To obtain service under warranty you must obtain a Returned Material Authorization (RMA) number from customer support (see *Service*, page 19). Products must be returned with transportation charges prepaid and must be accompanied by a brief description of the problem encountered and proof of date and place of purchase. This warranty does not apply to equipment which has been damaged by accident, negligence, or misapplication or has been altered or modified in any way. This warranty applies only to the original purchaser who must have properly registered the product within 10 days of purchase.

EXCEPT AS PROVIDED HEREIN, AMERICAN POWER CONVERSION MAKES NO WARRANTIES, EXPRESSED OR IMPLIED, INCLUDING WARRANTIES OF MERCHANTABILITY AND FITNESS FOR A PARTICULAR PURPOSE. Some states do not permit limitation or exclusion of implied warranties; therefore, the aforesaid limitation(s) or exclusion(s) may not apply to the purchaser.

EXCEPT AS PROVIDED ABOVE, IN NO EVENT WILL APC BE LIABLE FOR DIRECT, INDIRECT, SPECIAL, INCIDENTAL, OR CONSEQUENTIAL DAMAGES ARISING OUT OF THE USE OF THIS PRODUCT, EVEN IF ADVISED OF THE POSSIBILITY OF SUCH DAMAGE. Specifically, APC is not liable for any costs, such as lost profits or revenue, loss of equipment, loss of use of equipment, loss of software, loss of data, costs of substitutes, claims by third parties, or otherwise.

Appendix A: XL Information

When used with external battery packs, the extended run (XL) UPS offers longer run times than a standard UPS and extra load protection during battery replacement. When replacing the batteries either in the UPS or battery pack(s), the UPS can still respond to a power disturbance using the remaining connected batteries. Please refer to the main sections of this *User's Manual* for basic information about the UPS. This appendix provides additional information needed to use extended run versions of the UPS.

XL Installation

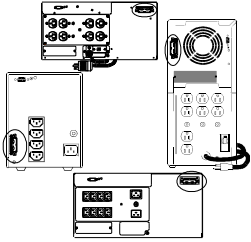







This figure shows the location of the battery pack connector on the 5U SU1400RMXL (top), the SU3000 tower unit (right), the 5U SU3000RM (bottom), and the SU1000XL tower unit (left). Some UPS models have the battery pack connector in different positions, but the size and shape of the connector is always the same.

Battery pack connectors are color coded as shown in the table below. Battery pack connectors are also keyed to prevent improper connection. Do not try to install battery packs with connectors that are a different color from the battery pack connector in the UPS.

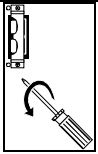
This UPS	Voltage	Uses this Battery Pack (connector color)	Maximum Number of Battery Packs
SU700XL SU1000XL	24 VDC	SU24XLBP (gray)	10
SU1400XLT SU2200XL SU2200XLT	48 VDC	SU48XLBP (blue)	10
SU3000 SU3000T SU3000RM	48 VDC	SU48BP (red)	1
SU1400RMXL SU1400RMXLT SU2200RMXL SU2200RMXLT	48 VDC	SU48RMXLBP(blue)	5

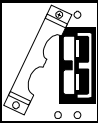
Install up to the maximum number of battery packs per XL model UPS following the instructions below.

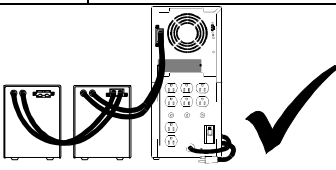
Note: The 3000 VA UPS accepts only one battery pack.

	<p>1. Prepare the UPS to connect the battery pack(s). Note the holes used to attach the battery pack connector clamp (near the center of the connector opening). Use a #2 Phillips head screwdriver to remove the battery pack connector clamp from the back of the UPS.</p>		<p>3. Holding the clamp aside, insert the battery pack connector into the UPS.</p>
	<p>2. Turn the clamp over and loosely attach one end at the edge of the connector opening in the UPS.</p>		<p>4. Secure the connector clamp.</p>
<div style="display: flex; align-items: center;">  <div style="margin-left: 10px;"> <p>Correctly completed XL installation with two battery packs.</p> </div> </div>		<p>For additional battery packs, repeat this procedure using the battery pack connectors on the battery packs.</p> <p>Caution: Do not stack battery packs. Stacking results in a tipping hazard.</p> <div style="display: flex; align-items: center; justify-content: center;">  </div>	

Smart-UPS Battery Protocol

Smart-UPS XL models are not designed to know how many external battery packs are connected to them. You must program the Smart-UPS XL with the appropriate number of external batteries in one of four ways.

Note:

It is important to follow these instructions. The number of batteries affects the run time calculations which Smart-UPS performs when it is running on battery power.

Use the Smart-UPS Battery Pack Utility (BATTPACK)

This program can be used with DOS or at a Microsoft® Windows DOS prompt.

BATTPACK cannot be used with a DOS emulator or VDM (virtual DOS machine) like those in Windows 95, Windows 98, or Windows NT.

The APC UPS Link cable must be used to communicate to the UPS. There are two black cables which can be used; part numbers 940-0024C or 940-1524C.

Note:

For the purposes of this formula, 1 rack mount battery pack (SU48RMXLBP) = 2 stand-alone battery packs.

At the DOS prompt, type: **battpack com[X] [Y]** where:

[X] represents the available serial port that Battery Pack Utility uses to access the Smart-UPS.

[Y] represents the number of external battery packs.

For example: C:> **battpack com1 4**

The black cable is attached to communication port 1. There are four external battery packs. The program confirms that the update is successful.

Use PowerChute® plus Version 5.x for Windows 95, Windows 98, Windows NT

PowerChute plus 5.x for Windows NT is compatible with NT 3.5.1 SP5, NT 4.0 Workstation (at least SP1), or NT 4.0 Server (at least SP1).

Install the software per the instructions on the CD.

After rebooting the computer, access the PowerChute *plus* graphical user interface.

1. Click on **Configuration**.
2. Click on **UPS Operating Parameters**.
3. Adjust the **External Battery Pack field** to the appropriate number of external batteries.
4. Click **OK**.

Use the Terminal Program to Change the Number of External Battery Packs

Terminal is used in Windows 3.1x, Windows for Workgroups, and Windows NT 3.51.

1. **EXIT** out of the PowerChute plus Server. In the case of Windows NT, the UPS Service must be stopped.
2. Go to: **Program Manager > Accessories > Terminal**. Double-click on the **Terminal** icon.
3. Select the COM port to which the black-colored interface cable is attached as the Connector.
4. The COM port settings are **2400 baud, 8 data bits, 1 stop bit, no parity, flow control is Xon/Xoff**.
5. Click **OK**.
6. Continue with the table in Step 7 in *Use the HyperTerminal Program to Change the Number of External Battery Packs*, page 22.

Use the HyperTerminal Program to Change the Number of External Battery Packs

HyperTerminal is used for Windows 95, Windows 98, and Windows NT 4.0

1. EXIT out of the PowerChute *plus* Server. In the case of Windows NT, the UPS service must be stopped.
2. From the Desktop, go to: **Start => Programs => Accessories => HyperTerminal**. Double-click on the **HyperTerminal** icon.
3. You are prompted to choose a name and select an icon. Give any name and then click **OK**. If a message appears which reads "...must install a modem," disregard it and continue.
4. The port settings are 2400 baud, 8 data bits, 1 stop bit, no parity, flow control is Xon/Xoff.
5. Click on **Advanced** and ensure the box labeled **FIFO buffer** is NOT checked.
6. Click **OK** twice.
7. Once the terminal/hyperterminal window is open, follow these steps:

Step Number	Type	Produced Effect
1	Y	Produces SM
2	>	To see the number of external packs. (A new unit will display 000 .)
3	+	Adds a battery pack.
4	>	To see the change in number of external battery packs.
5	-	Subtracts a battery pack.
6	>	To see the change in number of external battery packs.

Appendix B: Types of Racks and Mounting Hardware

This appendix describes the hardware required for the different types of racks and describes the type of racks that may be used in your industry. All APC rack mount units are shipped ready for 19-inch wide EIA/IEC rack cabinets. Some rack mount UPSs ship with rails included, otherwise, the rails are available as an option. Refer to the instructions included with the rails when mounting the UPS.

Racks

There are different types of racks:

Equipment Rack - usually an open rack with threaded mounting holes or no threaded holes

APC Netshelter, IBM (Vero, others) - enclosed rack with square holes

Dell, Compaq (Rittal) - enclosed rack with square holes

HP Rack - enclosed rack with round holes

These racks differ in the methods required for mounting equipment. They may have threaded holes (hardware not included), round holes (require clip nuts), or square holes (require cage nuts). See page 3 for examples of clip and cage nuts.

Telecomm Rack - open rack with two poles / four poles and threaded round holes (hardware not supplied by APC).

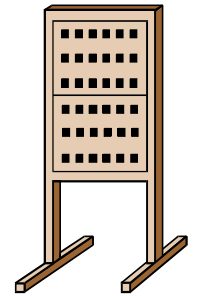
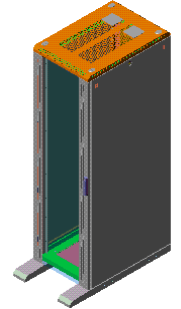

Notes:

**Remove batteries to reduce UPS weight.
For larger, heavier units, installation requires two people.**

Check the type of rack you have against the hardware required for mounting in the table below.

Rack Type	Hole Type	Hardware Required	Hardware Included
Equipment Rack	Threaded or No Threads	See rack specifications if threaded. If not threaded use APC hardware.	N/A if threaded. If not threaded use APC hardware.
Netshelter/Compaq/IBM/Dell	Square	Cage nut, 10-32 screws	810-2008, 810-0002
HP	Round	Clip nut, 10-32 screws	810-2004, 810-0002
Telecomm	Threaded	See rack specifications	N/A

Appendix C: Transporting Your Smart-UPS

Follow these guidelines if you need to ship the UPS to another location. These guidelines apply whether you are transporting the UPS alone, rack mounted in an equipment cabinet, or installed in a system.

Caution:

Always DISCONNECT THE BATTERIES before shipping the UPS to avoid damage during transport. (U.S. Federal Regulation *requires* that batteries be disconnected during shipment.) The batteries may remain in the UPS; they do not have to be removed.

This requirement applies whether the UPS is shipped alone or installed in an equipment rack or system.

Note:

Graphics are not drawn to scale. They are shown for reference only.

The battery compartment is accessed from the front panel of the UPS. The SU5000 unit, shown as an example, has four battery packs (each with four individual batteries).

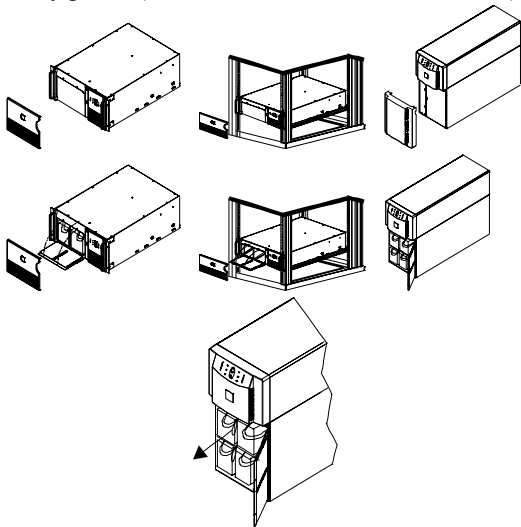

1. Remove the front bezel by grasping the finger clips on the side of the bezel and carefully loosening the four (4) snaps.
2. Use a screwdriver or coin to remove the two battery door screws and open the door.
3. Disconnect the front battery pack. Grasp the white cord on the first front set of batteries and pull firmly to disconnect the connector from the battery compartment.
4. Tuck the white cord (that serves as a handle for the connector) neatly to the side.
5. Disconnect the remaining battery packs by repeating steps 3 and 4.
6. Once all the batteries have been disconnected, close the battery door and replace the two (2) screws removed in step 2.
7. Align the front bezel with the opening on the front of the UPS and snap it into place.

Note:

Remember to connect the batteries once the UPS has arrived at its destination.